

NOTES:

1. 13.5 TURNS TO OPEN/CLOSE
2. PIPE OPTIOINS: IPS DR11, DIPS DR11, IPS DR09 & DIPS DR09
3. COMPLIES WITH NSF 61
4. MAXIMUM ALLOWABLE TORQUE, PER AWWA, IS 75 FT*LBS

M&H VALVE COMPANY
ANNISTON, ALABAMA
A DIVISION OF MCWANE INC.

DWG. NO.
RS-HDPE-04

DWN: CTJ	REV
DATE: 9/26/22	—

4" AWWA C515 RESILIENT SEATED
GATE VALVE
HDPE X HDPE CONNECTION
2" AWWA OP NUT - OPEN LEFT

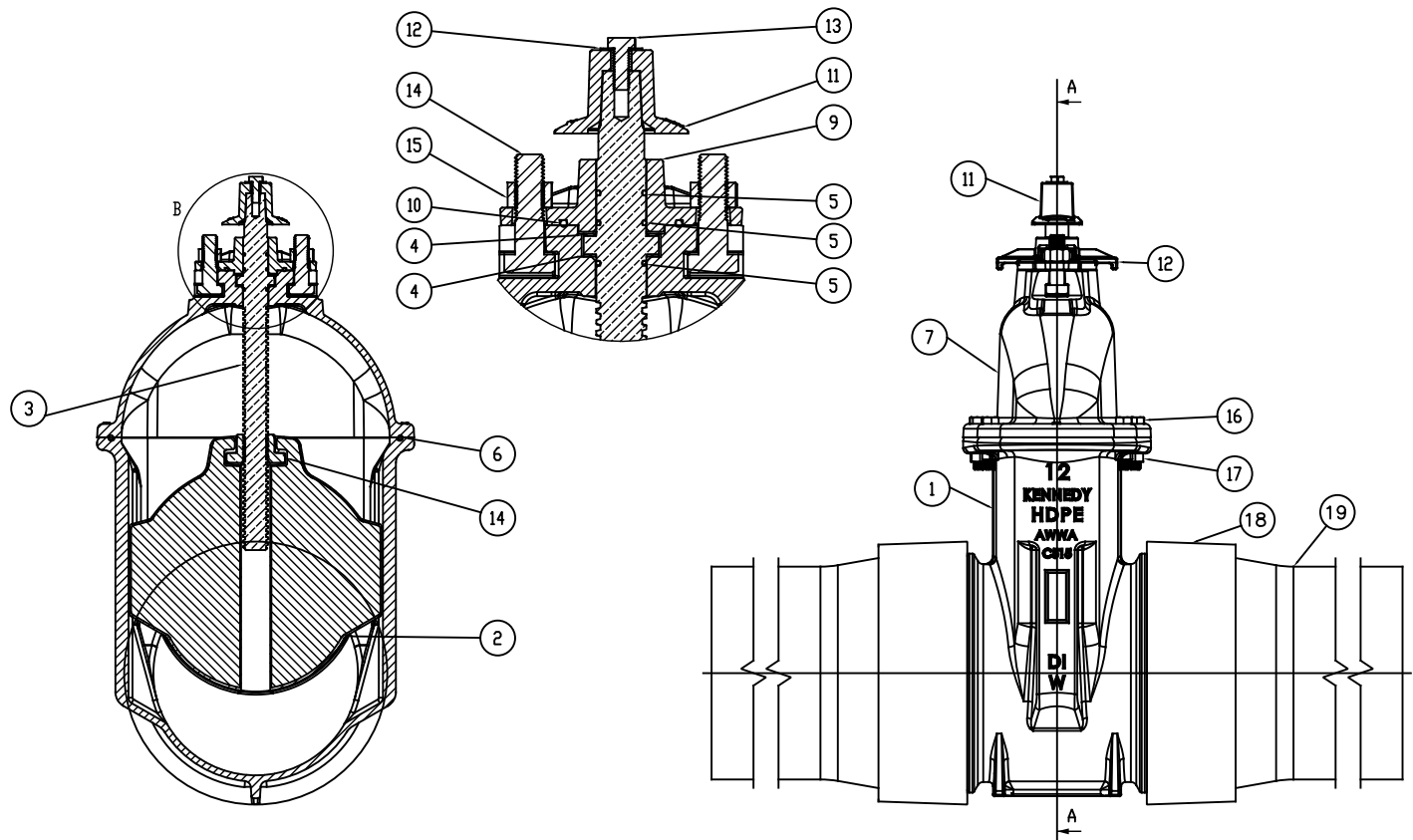

ITEM	DESCRIPTION	MATERIAL
1	VALVE BODY	DUCTILE IRON
2	WEDGE	EPDM / DUCTILE IRON
3	STEM	C86700
4	THRUST WASHER	ACETAL
5	O-RING ; -218	EPDM
6	O-RING ; -455	EPDM
7	BONNET	DUCTILE IRON
8	STEM NUT	C87850
9	SEAL PLATE	DUCTILE IRON
10	O-RING ; -339	EPDM
11	OPERATING NUT	CAST IRON
12	WASHER	18-8 SS
13	HEX HEAD CAP SCREW	18-8 SS
14	HEX HEAD CAP SCREW	18-8 SS
15	HEX NUT	18-8 SS
16	HEX HEAD CAP SCREW	18-8 SS
17	HEX NUT	18-8 SS
18	HDPE RING	DUCTILE IRON
19	HDPE PIPE SECTION	HIGH DENSITY POLYETHYLENE

M&H VALVE COMPANY
ANNISTON, ALABAMA
A DIVISION OF MCWANE INC.

DWG. NO.
RS-HDPE-BOM

DWN: CTJ	REV
DATE: 9/26/22	—

2" - 12" AWWA C515 RESILIENT SEATED
GATE VALVE
HDPE X HDPE CONNECTION
BILL-OF-MATERIAL